



SKIMP™

S/S 2020



A CRAZY, AUDACIOUS & COLORFUL BRAND !

Since 2009, the French brand SKIMP from Lyon designs and recreates daily accessories to make them FUN, SMART and ORIGINAL.

SKIMP is above all a story of adventure and travels. Have you ever heard of these famous colorful plastic belts ? Next time you are at the airport, on a golf course or even a ski slope, look very closely, you might notice one of them !

Ever since, all our designers love playing with colors and textures always more surprising. From plastic belt loops to light weight foam handbags to a full range of tarpaulin bags ... The brand asserts its image with energy and originality.

Here at SKIMP, we love not taking ourselves too seriously and to rewrite the codes in a very colorful way.

And the best part is that all our creations are certified 100% authentic and smart.



UNE MARQUE AUDACIEUSE, DÉLIRANTE & COLORÉE !

Depuis 2009, la marque lyonnaise SKIMP conçoit et réinvente les objets du quotidien pour les rendre FUN, INGENIEUX & DECALÉS.

SKIMP, c'est avant tout une histoire d'aventures et de voyages. Avez-vous déjà entendu parler des fameuses ceintures en plastique de toutes les couleurs ? Regardez bien la prochaine fois que vous serez dans un aéroport, sur un parcours de golf ou encore une piste de ski... Vous y croiserez sûrement l'une d'entre elles !

Toute notre équipe de design adore s'amuser avec des coloris et des matériaux aux textures toujours plus improbables : partant des ceintures en plastiques, aux sacs à main en mousse ultra-légère, en passant par des sacs en bâche... La marque s'affirme avec pep's et originalité.

Chez SKIMP, on ne se prend pas au sérieux et on bouscule les codes, le tout dans un style coloré affirmé.

Et pour ne rien gâcher, nos créations sont garanties 100% authentiques et astucieuses.





**WE
LOVE
FASHION**





**WE
LOVE
SPORTS**





**WE LOVE
ADVENTURES**



The background features a repeating pattern of geometric shapes, including squares and rectangles with internal lines, arranged in a grid. The colors transition from a bright yellow-green on the left to a dark blue on the right.

CEINTURES

BELTS

AVANTAGES PRODUIT / PRODUCT ADVANTAGES



washable

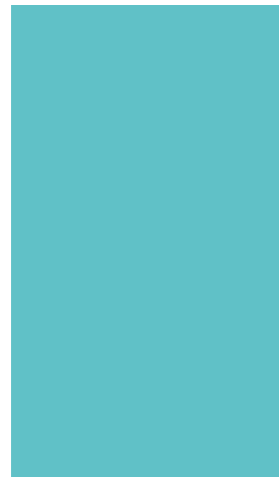

Un entretien facile,
nettoyez-les à l'eau
et au savon

Washable with
soap and water



weather resistant

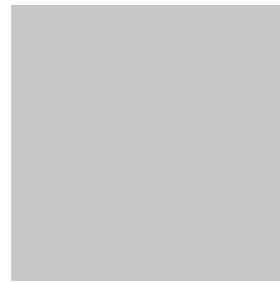

Résistant aux
conditions extrêmes
(de -20°C à
+50°C)

Resists to extreme
weather conditions
(from -4 up to
122 Fahrenheit
degrees)



waterproof



one size fits all



Ceintures pour homme, femme ou enfant
Taille unique, ajustable à toutes les morphologies
Fermeture facile grâce au système de boucle easy
clip

*Belts for men, women and children
One size fits all
Easily adjustable due to its easy clip buckle*



antibacterial
antiallergic



metal free



Aucun composant
métallique

*No metallic
component*



recyclable

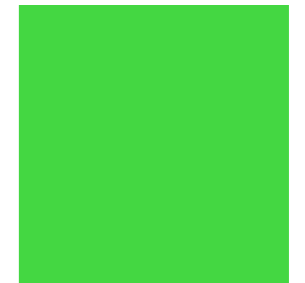

Matière plastique
TPE- boucle en
polycarbonate

*Materials:
TPE plastics-
polycarbonate
buckle*

GAMME CEINTURES / BELT RANGE

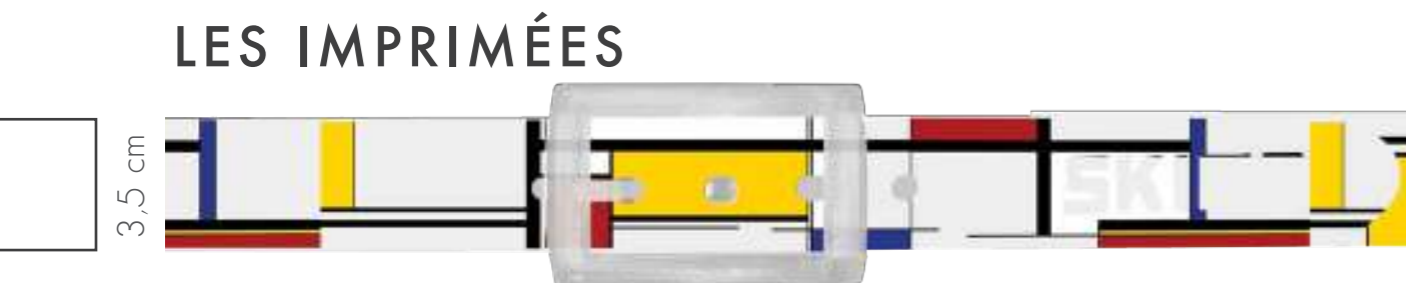
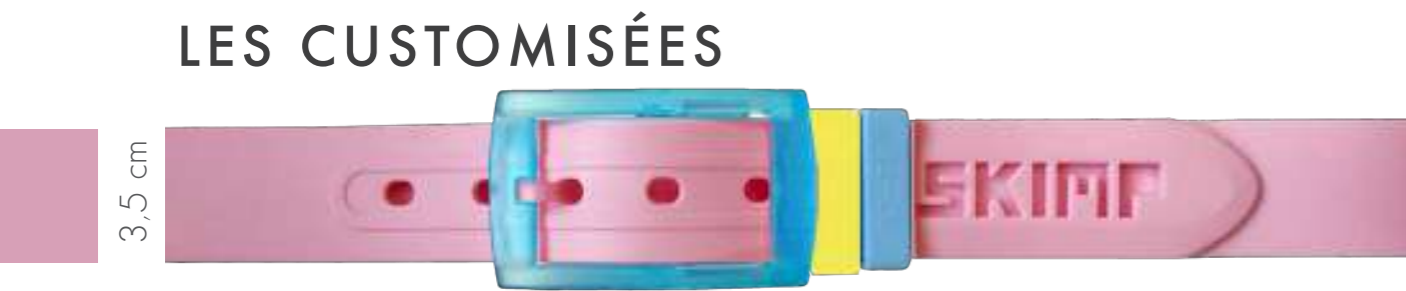
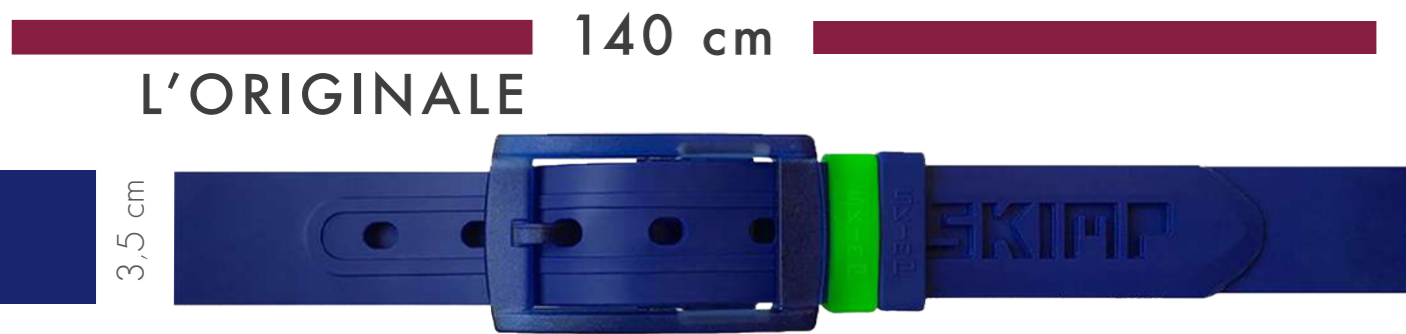

Caractéristiques techniques

- Ceinture en élastomère thermoplastique RECYCLABLE 
RECYCLABLE thermoplastic elastomer belt
- Boucle en polycarbonate
Polycarbonate buckle
- Passants SKIMP interchangeable pour ceintures 3,5cm
SKIMP loops interchangeable for 3.5 cm belts

CEINTURES / BELTS 3,5cm

L'Originale



White



Light pink



Fuchsia



Old Pink



Burgundy



Red



Orange



Yellow



Fluo green



Turquoise



Sky blue



Azure blue



Old blue



Dark Blue



Navv



Glow



Light grey



Dark grey



Beige



Brown



Purple



Dark green



Army Green



Black

CEINTURES / BELTS 3,5cm

La Sauvage



Black



Navy



Red



Dark grey



Brown

Les Customisées



LA BRITISH
Navy



LA BRESILIENNE
Yellow



L'ESPERANÇA
Green



LA FRENCHIE
White



MIAMI SUNSET
Light Pink



LA NAUTIQUE
Light Blue



L'IRLANDAISE
White



L'AVENTURIÈRE
Beige

CEINTURES / BELTS 3cm & 2cm

L'Artistique : 3cm



Orange



Red



Fuchsia



Sky blue



Yellow



Black



Navy



White



Light grey

La Charmeuse : 2cm



Light grey



Duck blue



Dark blue



Blue jeans



Beige



Black



Burgundy



Army green



White

La Sportive : 2cm



Navy



Light pink



Red



Orange

CEINTURES / BELTS 3,5cm

Les Imprimées



HUBERT PRIVE



VACANCES AU SKI



L'INEDITE



LA PATRIOTE



SAVOIE



PETITS BATEAUX



DRAPEAUX MARINS



BREIZH CLUB



GOLFIQUE

CEINTURES / BELTS 3,5cm

Black & White

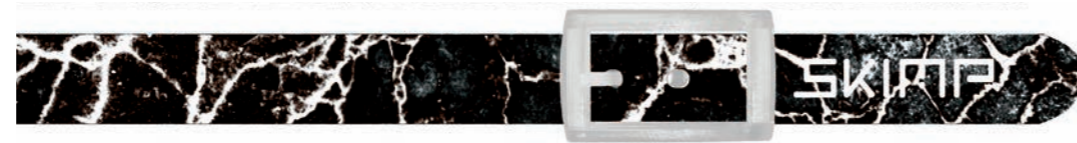

BLACK STONE



WHITE STONE



B&W INVADERS



B&W POP SQUARE



INVADERS



POINTILLÉS

CEINTURES / BELTS 3,5cm

Pop Square



BRESILIENNE



HALLOWEEN



PINK FLAMINGO



WEED



FLASHY



AUTUMN

CEINTURES / BELTS 3,5cm

All Over



ALL OVER BRESILIENNE



ALL OVER HALLOWEEN



ALL OVER FLASHY



ALL OVER WEED



ALL OVER POP



ALL OVER AUTUMN

CEINTURES / BELTS 3,5cm

Stripes & Dots



STRIPES 1



DOTS 1



STRIPES 2



DOTS 2



STRIPES 3

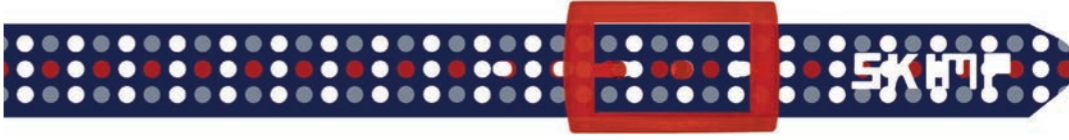

DOTS 3



STRIPES 4

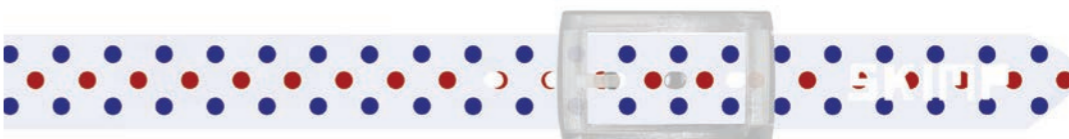

DOTS 4

CEINTURES / BELTS 3,5cm

Museum Collection

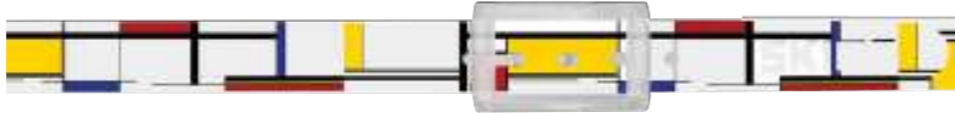

LA GÉOMÉTRIQUE



HOKUSAÏ WAVES



BLUE MALEVITCH



VAN GOGH



AUTUMN FACES



GREEN MALEVITCH



RAINBOW



by KAMEL

ACCESSOIRES / ACCESSORIES

Personnalisez votre Skimp selon votre humeur grâce à notre grand choix de passants et de boucles interchangeables.

Boucles vendues à l'unité. Adaptables pour les ceintures de **3.5cm**.

Customize your Skimp according to your mood thanks to our wide selection of loops and interchangeable buckles.

Buckles sold individually. Only available for the 1.3 inch belts.

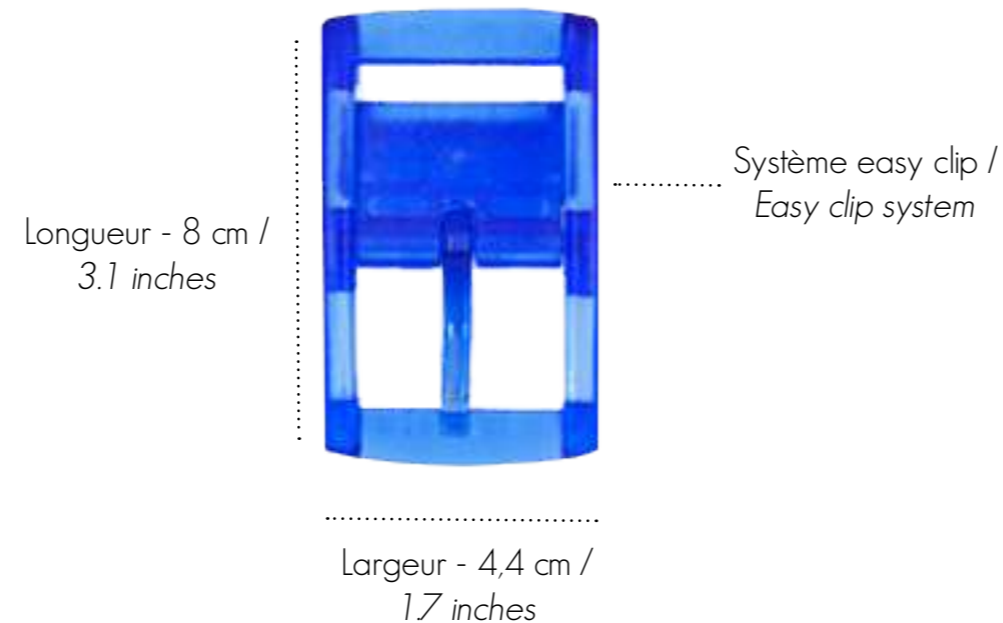

Boucles - Buckles



Boîte de 144 passants
Box of 144 loops

CUSTOMISATION

Personnalisez votre ceinture en changeant boucle et/ou passants
Personalize your belt by changing buckles and loops



Autres exemples de customisation / other examples of customization ...



CREEZ VOTRE CEINTURE SKIMP / CREATE YOUR BELT

UN ARTISTE ... UNE CEINTURE

Vous avez une âme d'artiste ou simplement une idée de visuel qui pourrait plaire à vos clients? Contactez-nous pour créer votre propre série limitée de ceinture.

You have an artist soul or only a visual idea that could please your customers?

Contact us to create your own limited edition belt.

NB : Les ceintures que vous allez voir ne sont pas des réalisations, mais des exemples de montages possibles

The belts shown are illustrations only

Tsunami Hokusai



Bold and Bright Piet Mondrian

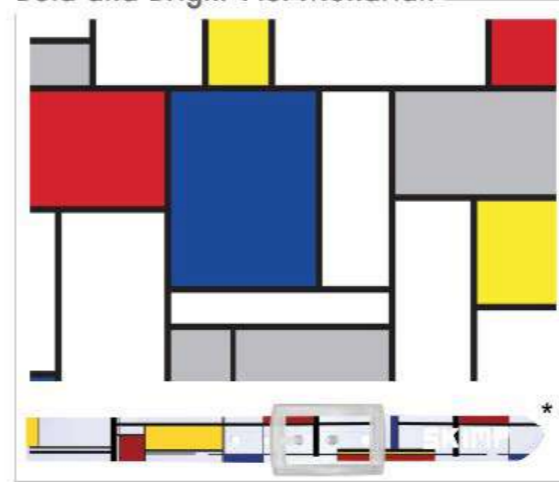

La nuit étoilée Van Gogh



Les femmes d'Alger Picasso



Yellow Red Blue Kandinsky



Motif Memphis

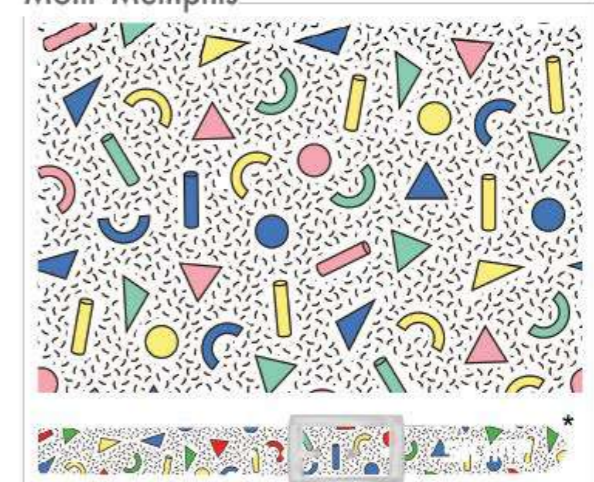

* Exemples de montage & réalisations / *examples of possible layouts*

CREEZ UNE CEINTURE A VOS COULEURS

CREATE YOUR BELT

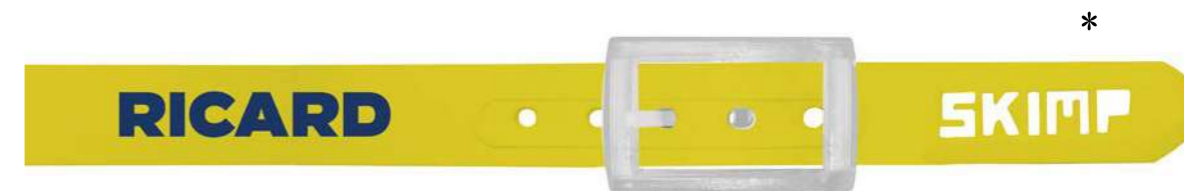

Caractéristiques techniques / *technical characteristics*

Impression sur base ceinture blanche

Printed on a white belt

Production par multiple de 60 pièces

Produced in multiples of 60 pieces

Délais de production - 15 jours

Production time - 15 days

Imprimée en France

Printed in France



* Exemples de montage & réalisations / *examples of possible layouts*



PACKAGING

Packaging en plexiglass empilable à volonté pour mettre en valeur les produits dans votre boutique. Gagnez de la place et amusez-vous à construire de nouvelles formes avec le « Playful packaging ».

Packaging in stackable plexiglas boxes to emphasize products in your shop. Enjoy building new display designs with our « Playful packaging ».



PLV - POS DISPLAY

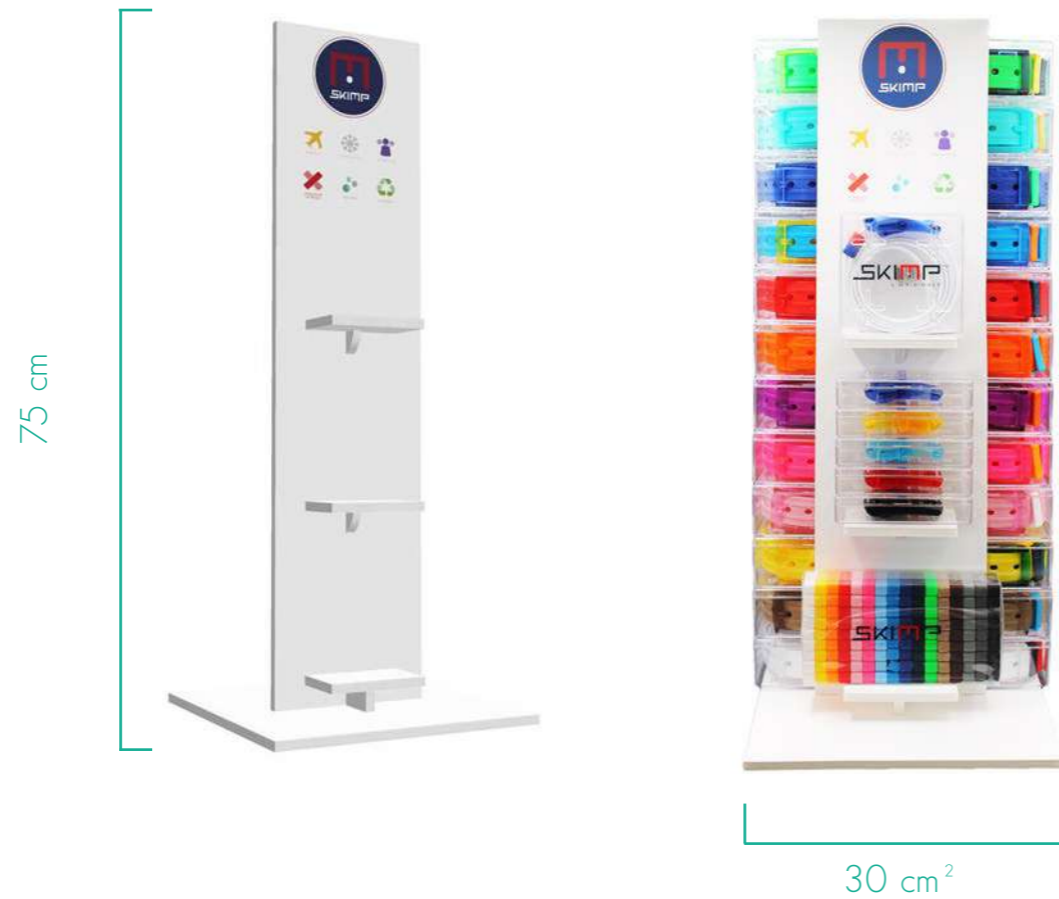

Présentoir ceintures - *Counter belt display*



Totem en carton - *Floor cardboard totem*

PLV - POS DISPLAY



1 boîte de passants - box of loops
5 boucles - buckles
25 ceintures - belts



45 ceintures - belts



27 ceintures - belts

MERCHANDISING

Le même présentoir se transforme en 3 versions possibles
The counter belt display can be built up in 3 different versions

The background features a smooth gradient from a deep blue on the left to a bright yellow on the right. Numerous translucent, spherical bubbles of varying sizes are scattered across the frame, some overlapping and others floating independently. The bubbles have a soft, ethereal quality, with light reflecting off their surfaces.

LUNETTES
SUN GLASSES

THE MASK

Lunettes de soleil
Sun glasses

155 x 65 x 35 mm



185 mm



Monture Polycarbonate ultra légère
PC Frame

Verre Polycarbonate
PC Lens

Lunettes ultra légère 42gr

Protection : 100 % UVA/ UVB
UV 400 cat. 3



GAMME DE COULEURS / COLOR RANGE



Gold - White



Rainbow - White



Black - Black



Silver- Black

JOIN THE TEAM





The background of the image is a vibrant blue surface covered with numerous water droplets of various sizes. The droplets are rendered with realistic lighting, showing highlights and shadows that give them a three-dimensional appearance. They are scattered across the entire frame, creating a textured and dynamic background.

SUR-CHAUSSURE
SHOES COVER

LA FÉTICHISTE

Sur-chaussure en silicone
Silicone Shoe Cover

Sur-chaussure waterproof et antidérapante
Waterproof and anti-slippery shoes cover



Taille/ Size



EU : 35-41



EU : 42-46

Info technique / Technical info

Semelle antidérapante / Anti-slippery sole

Utilisation extérieure / Outdoor use

Imperméable / Waterproof

100 % Silicone

Mode d'emploi / Manual



weather resistant



anti-slippery



waterproof



french design

GAMME DE COULEURS / COLOR RANGE



Black



Orange



Navy

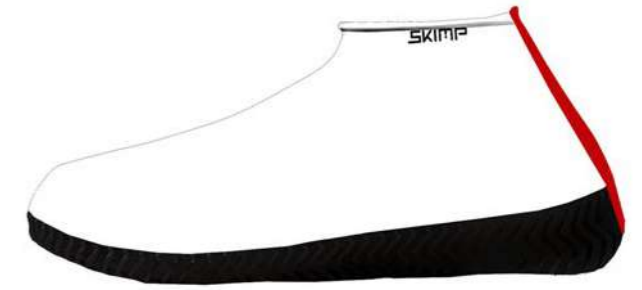

White transparent

Une protection en toute saison...



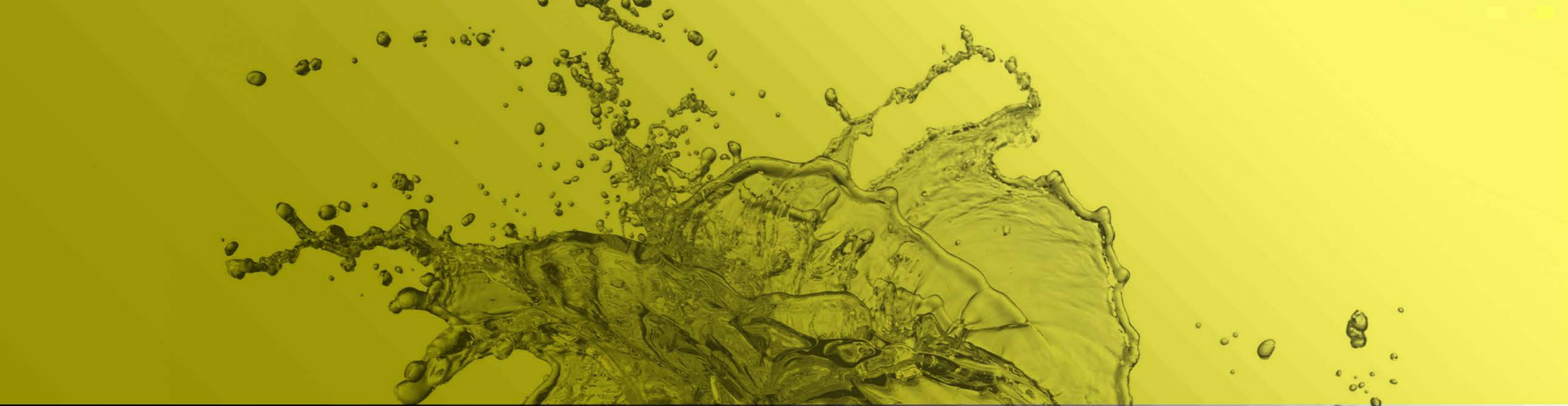

BAGGAGERIE
LUGGAGE

AVANTAGES PRODUIT / PRODUCT ADVANTAGES



weather resistant

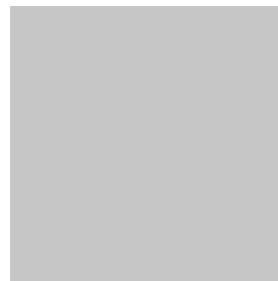

Résistant aux conditions extrêmes (de -20°C à +50°C)

Resists to extreme weather conditions (from -4 up to 122 Fahrenheit degrees)

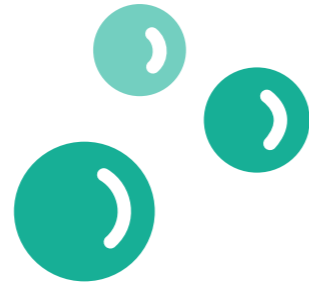

easy clean



Un entretien facile, nettoyez-les à l'eau et au savon

Easy maintenance, washable with soap and water



waterproof



Toile de bâche en PVC waterproof
Waterproof PVC tarpaulin

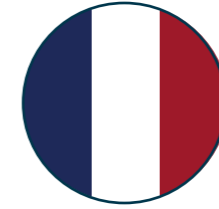

French design



Design Français
All our products are designed in Lyon (FRANCE)

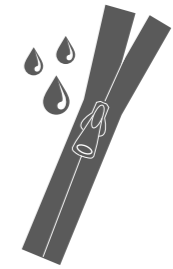

waterproof zip



La Fidèle et le Dandy ont un zip étanche

Waterproof zip for "Fidèle" and "Dandy"



LE NOMADE



LE DANDY



LA CONNECTÉE



L'INFIDÈLE



LA FIDÈLE

Toile de bâche en PVC waterproof
Waterproof PVC tarpaulin

LE NOMADE

Sac de voyage
Travel bag



Anses extra-longues porté épaules
Extra-long handles to carry as a shoulder bag

Bâche en PVC étanche
Waterproof tarpaulin



1 poche intérieure de
sécurité zippée
1 inside zipped security
pocket

2 poches extérieures
2 outside pockets

Longueur : 38 (bas) cm Length : 14.9 (bottom) inches
54 (à l'ouverture) cm 21 (opening) inches
Profondeur: 21 cm / Depth: 8.6 inches
Hauteur : 34 cm / Height: 13.3 inches

GAMME DE COULEURS / COLOR RANGE



Orange



Black



Red



Yellow



Fuchsia

LE DANDY

Sac à dos
Backpack

Toile de bâche en PVC waterproof
Waterproof PVC tarpaulin

Poignée pour porté cartable
Briefcase carry handle



Poche extérieure zippée
Outer zip pocket



INTERIEUR/ INSIDE:

Compartiment matelassé, pour ordinateur 15 pouces

Inside padded pocket, suitable for a 15" laptop

3 poches de rangement

3 inside pockets

43 x 32.5 x 14 cm

16.9 x 12.8 x 15.5 inches



Anses réglables et déclipables qui se rangent dans poche extérieure

Adjustable and removable handles stowed in an outside pocket

GAMME DE COULEURS / COLOR RANGE



Black



Grey



Army green



Dark blue

LA CONNECTÉE

Pochette d'ordinateur
Computer sleeve

Grande poche zippée et matelassée
Large inside zipped and padded pocket



Poche extérieure zippée
Outside zipped pocket

Toile de bâche en PVC waterproof
Waterproof PVC tarpaulin

TAILLE M - SIZE M
23 x 33 x 2.5 cm
(15 pouces)
9 x 12 x 0.7 inches
(display size: 15")



TAILLE S - SIZE S
20 x 28.5 x 2 cm
(mini->12 pouces)
7.8 x 11 x 0.7 inches
(mini->12")



Orange



Army green



Azure blue



Dark blue



Red



Black



Yellow



Grey



Fuchsia

L'INFIDÈLE

Trousse de toilette
Toiletry bag

25 x 16 x 9 cm
9.8 x 6.2 x 3.5 inches

Anse extérieure
Outer handle



Fermeture zippée
Closable with a zipper



Toile bâche PVC waterproof
Waterproof PVC tarpaulin



Yellow



Black



Azure blue



Fuchsia



Grey



Red



Orange



Army green

LA FIDÈLE

Pochette
Pouch

Lanière extérieure avec bouton pression
Outer strap with button snap closure

Toile de bâche en PVC waterproof
Waterproof PVC tarpaulin



30 x 19 cm
11.8 x 7.5 inches



Fermeture zippée étanche
Closable with a waterproof zipper



Grey



Fuchsia



Army green



Orange



Red



Dark blue



Yellow



Black



Azure blue

The background features a repeating pattern of overlapping circles. The colors transition from a bright orange on the left to a deep purple on the right. Each circle contains a smaller, semi-transparent version of itself, creating a layered effect.

CITY BAGS

AVANTAGES PRODUIT / PRODUCT ADVANTAGES



lightweight



Léger comme une plume

As light as a feather

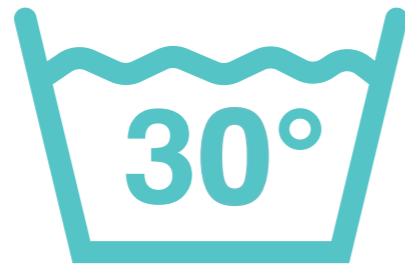

washable



Lavage à froid

Cold wash



rainproof

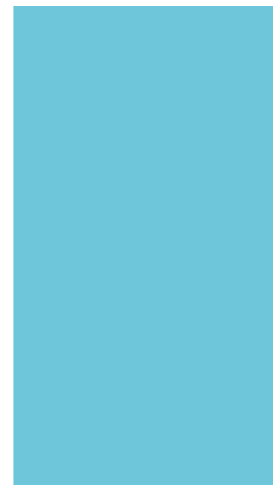

Mousse recouverte de maille déperlante

Foam coated with water repellent fabric

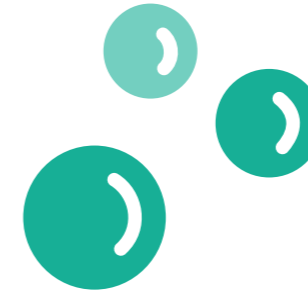

easyclean



Un entretien facile, nettoyez-les à l'eau et au savon

Easy maintenance, washable with soap and water

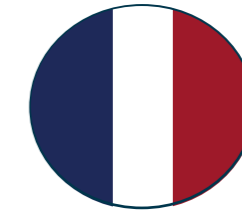

French design



Design Français

All our products are designed in Lyon (FRANCE)



LE COMPLICE



LE FELIX L



L'INDOMPTABLE



LE MALICIEUX



LA DISCRÈTE



LA SECRÈTE

LE COMPLICE

Fermeture zippée
Closable with a zipper

Anse extra longue/possibilité de le
portée à l'épaule
*Hanse extra long / possibility to wear it
on the shoulder*

Mousse recouverte de maille
déperlante.
*Foam covered with water repellent
mesh*

48 x 22 x 24 cm
19 x 9 x 10 inches
250g



Fuschia



Yellow



Army green



Dark blue



Orange



Red



Azur blue



Emerald

L'INDOMPTABLE

Porté main ou bras
Carried by hand or arm

Bouton pression de chaque côté, fermeture centrale
par bouton pression
Press studs on each side, central snap closure



Fond rigide amovible
Removable rigid bottom

Deux formes possibles
Two possible shapes



23,5 x 30 x 11,5 cm
117 grammes

9.25 x 11.81 x 4.52 inches
0.26 pounds



Beige



Grey



Brown



Burgundy



Duck blue



Emerald



Army green



Black



Burgundy & dark blue



Dark blue & sky blue



Dark blue & water green



Duck blue & grey



Black & dark blue

LE FÉLIX «L»



Mousse recouverte de maille déperlante
Foam coated with water repellent fabric



Fond rigide amovible
Removable rigid bottom

Porté main, bras ou épaule
Carried by hand, arm or shoulder

Fermeture centrale par bouton
pression
Central snap closure

31 x 30 x 17 cm
170 grammes

12.20 x 11.81 x 6.69 inches
0.38 pounds



Light pink



Water green



Orange



Red



Burgundy



Sky blue



Emerald



Army green



Grey



Beige



Brown

LE MALICIEUX

Bandoulière réglable
Adjustable shoulder strap

Fermeture zip
Zip closure

Poche intérieure zippée
Inside zipped pocket

Poche extérieure fermée par bouton pression
Outside pocket with a snap closure

Largeur - 18 cm
Longueur - 18 cm
Profondeur - 5 cm

Width - 7.08 inches
Length - 7.08 inches
Depth - 1.9 inches

Néoprène & similicuir
Neoprene & fake leather

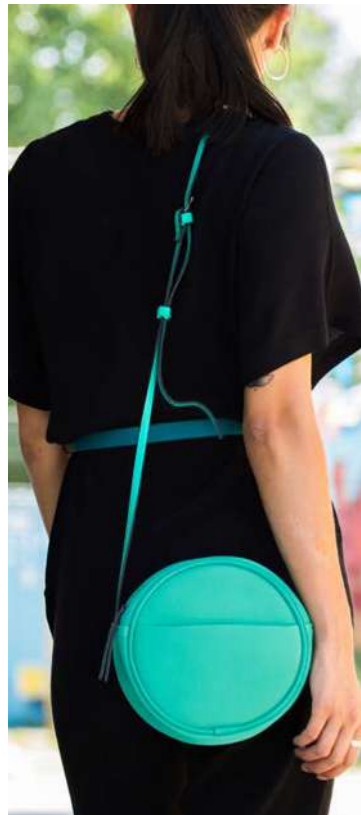

Black



Dark blue



Green



Fuchsia



Orange



Yellow

LA DISCRÈTE pochette - pouch



Fermeture éclair
Zip fastener



20 x 15 x 3 cm
38 grammes

Mousse recouverte de maille déperlante
Foam coated with water repellent fabric



Light pink



Fuchsia



Orange



Red



Beige



Sky blue



Azure blue



Dark blue



Black

LA SECRÈTE pochette - pouch



Petit noeud décoratif
Beautiful small knot



Fermeture éclair
Zip fastener

18 x 12 x 5 cm
28 grammes

Mousse recouverte de maille déperlante - ne pas repasser
Foam coated with water repellent fabric - no ironing



Yellow



Light pink



Sky blue



Azure blue



Duck blue



Dark blue



Brown

The background features a vibrant blue gradient on the right side, transitioning into a series of overlapping, wavy, translucent shapes in shades of orange and red on the left side. These shapes resemble liquid or smoke, creating a dynamic and abstract visual effect.

MORE ABOUT US

SALONS / FAIRS



Nautic



MERCHANDISING IN STORE

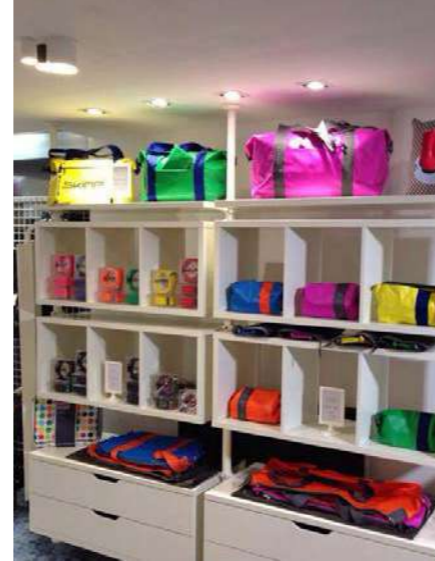



CONTACT

l'univers de Skimp vous plaît ? - *do you like Skimp's universe ?*

www.skimp.fr

Follow us :

 Facebook
[skimp.page.officielle](https://www.facebook.com/skimp.page.officielle)
[skimpsport](https://www.facebook.com/skimpsport)

 Instagram
[@skimpfrance](https://www.instagram.com/skimpfrance)
[@skimpsport](https://www.instagram.com/skimpsport)

 Pinterest
[@skimpfrance](https://www.pinterest.com/skimpfrance)

Contactez nous - *Please contact us :*

SALES & MARKETING

SKIMP
60 Rue Lucette et René Desgrand
69100 Villeurbanne
FRANCE

Email : chb@skimp.fr
Bureau / office : 04 27 82 99 23
Mobile : 06 09 91 22 45