

The background features a repeating pattern of geometric shapes, including squares and rectangles with rounded corners, arranged in a grid. The colors transition from a bright yellow-green on the left to a dark blue on the right. The shapes are outlined in a slightly darker shade of the background color.

**CEINTURES**

**BELTS**

# AVANTAGES PRODUIT / PRODUCT ADVANTAGES



washable

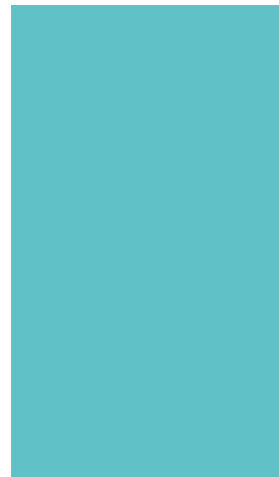

Un entretien facile,  
nettoyez-les à l'eau  
et au savon

-----  
Washable with  
soap and water



weather resistant



Résistant aux  
conditions extrêmes  
(de -20°C à  
+50°C)

-----  
Resists to extreme  
weather conditions  
(from -4 up to  
122 Fahrenheit  
degrees)



waterproof



one size fits all



Ceintures pour homme, femme ou enfant  
Taille unique, ajustable à toutes les morphologies  
Fermeture facile grâce au système de boucle easy  
clip

-----  
*Belts for men, women and children  
One size fits all  
Easily adjustable due to its easy clip buckle*



antibacterial  
antiallergic

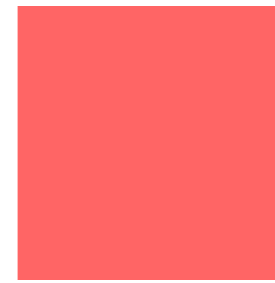

metal free



Aucun composant  
métallique

-----  
*No metallic  
component*



recyclable

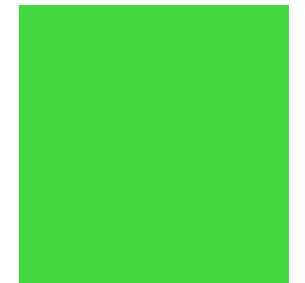

Matière plastique  
TPE- boucle en  
polycarbonate

-----  
*Materials:  
TPE plastics-  
polycarbonate  
buckle*

# GAMME CEINTURES / BELT RANGE

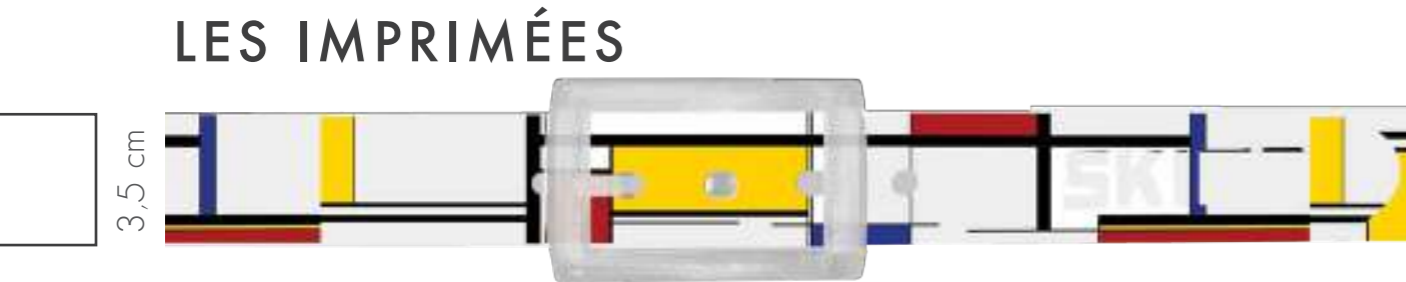
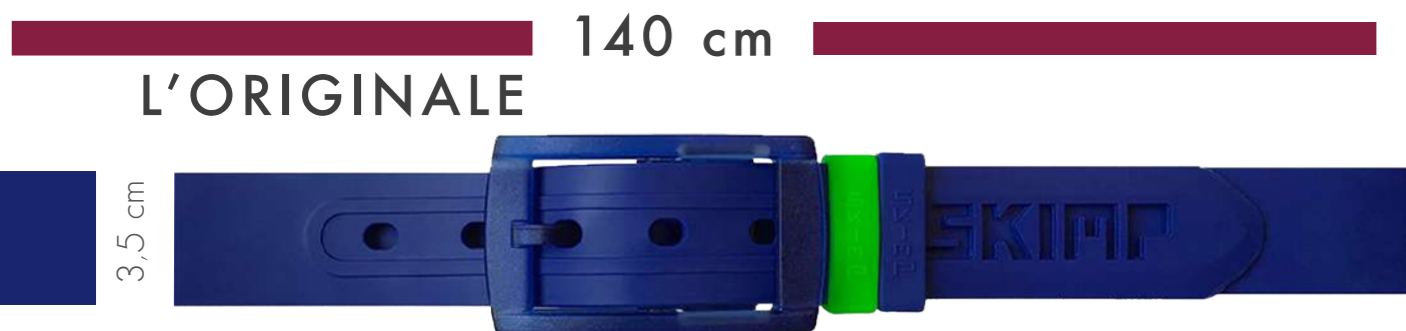

## Caractéristiques techniques

- Ceinture en élastomère thermoplastique RECYCLABLE   
*RECYCLABLE thermoplastic elastomer belt*
- Boucle en polycarbonate  
*Polycarbonate buckle*
- Passants SKIMP interchangeable pour ceintures 3,5cm  
*SKIMP loops interchangeable for 3.5 cm belts*

# CEINTURES / BELTS 3,5cm

## L'Originale



White



Light pink



Fuchsia



Old Pink



Burgundy



Red



Orange



Yellow



Fluo green



Turquoise



Sky blue



Azure blue



Old blue



Dark Blue



Navv



Glow



Light grey



Dark grey



Beige



Brown



Purple



Dark green



Army Green



Black

# CEINTURES / BELTS 3,5cm

## La Sauvage



Black



Navy



Red



Dark grey



Brown

## Les Customisées



LA BRITISH  
Navy



LA BRESILIENNE  
Yellow



L'ESPERANÇA  
Green



LA FRENCHIE  
White



MIAMI SUNSET  
Light Pink



LA NAUTIQUE  
Light Blue



L'IRLANDAISE  
White



L'AVENTURIÈRE  
Beige



# CEINTURES / BELTS 3cm & 2cm

## L'Artistique : 3cm



Orange



Red



Fuchsia



Sky blue



Yellow



Black



Navy



White



Light grey

## La Charmeuse : 2cm



Light grey



Duck blue



Dark blue



Blue jeans



Beige



Black



Burgundy



Army green



White

## La Sportive : 2cm



Navy



Light pink



Red



Orange

# CEINTURES / BELTS 3,5cm

## Les Imprimées



HUBERT PRIVE



VACANCES AU SKI



L'INEDITE



LA PATRIOTE



SAVOIE



PETITS BATEAUX



DRAPEAUX MARINS



BREIZH CLUB



GOLFIQUE

# CEINTURES / BELTS 3,5cm

## Black & White



BLACK STONE



WHITE STONE



B&W INVADERS



B&W POP SQUARE



INVADERS



POINTILLÉS



# CEINTURES / BELTS 3,5cm

## Pop Square



BRESILIENNE



HALLOWEEN



PINK FLAMINGO



WEED



FLASHY



AUTUMN

# CEINTURES / BELTS 3,5cm

## All Over



ALL OVER BRESILIENNE



ALL OVER HALLOWEEN



ALL OVER FLASHY



ALL OVER WEED



ALL OVER POP



ALL OVER AUTUMN

# CEINTURES / BELTS 3,5cm

## Stripes & Dots



STRIPES 1



STRIPES 2



STRIPES 3



STRIPES 4



DOTS 1



DOTS 2

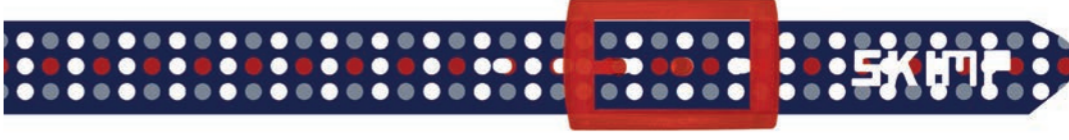

DOTS 3

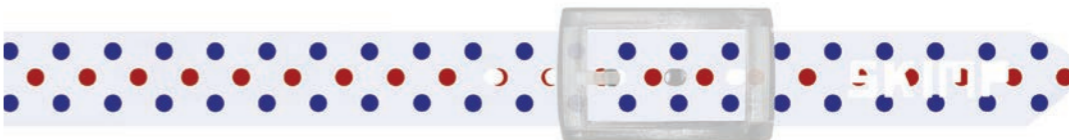

DOTS 4

# CEINTURES / BELTS 3,5cm

## Museum Collection

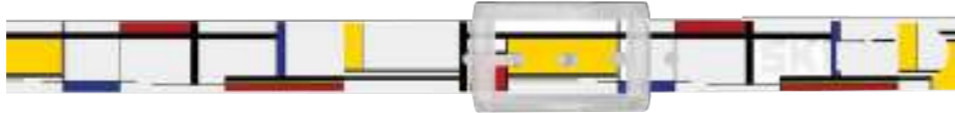

LA GÉOMÉTRIQUE



HOKUSAÏ WAVES



BLUE MALEVITCH



VAN GOGH



AUTUMN FACES



GREEN MALEVITCH



RAINBOW



by KAMEL



# ACCESSOIRES / ACCESSORIES

Personnalisez votre Skimp selon votre humeur grâce à notre grand choix de passants et de boucles interchangeables.

Boucles vendues à l'unité. Adaptables pour les ceintures de **3.5cm**.

Customize your Skimp according to your mood thanks to our wide selection of loops and interchangeable buckles.

Buckles sold individually. Only available for the 1.3 inch belts.

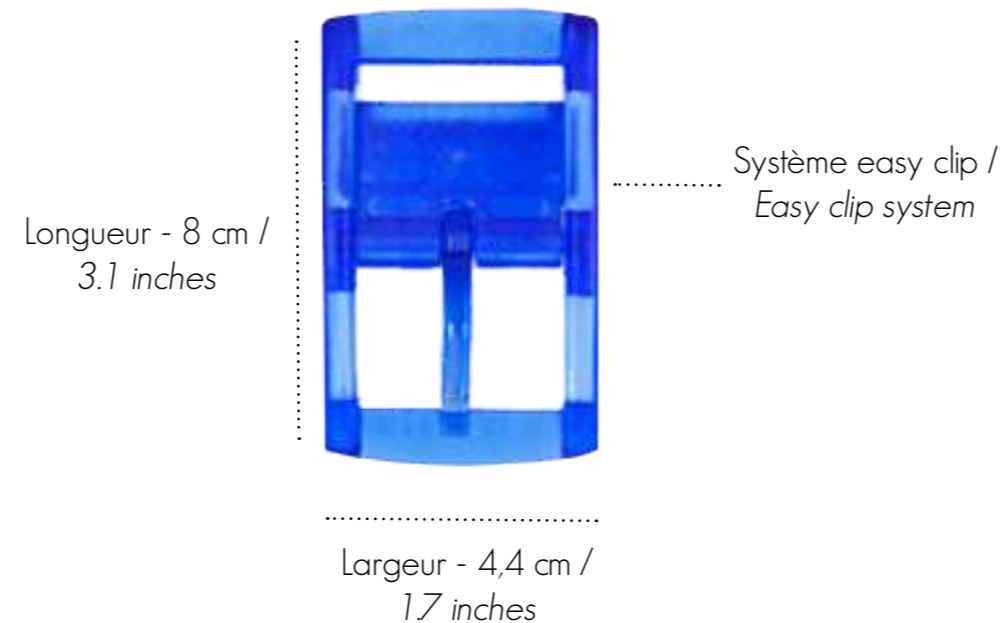

Boucles - Buckles



Boîte de 144 passants  
Box of 144 loops



# CUSTOMISATION

Personnalisez votre ceinture en changeant boucle et/ou passants  
Personalize your belt by changing buckles and loops



Autres exemples de customisation / other examples of customization ...



# CREEZ VOTRE CEINTURE SKIMP / CREATE YOUR BELT

## UN ARTISTE ... UNE CEINTURE

Vous avez une âme d'artiste ou simplement une idée de visuel qui pourrait plaire à vos clients? Contactez-nous pour créer votre propre série limitée de ceinture.

*You have an artist soul or only a visual idea that could please your customers?*

*Contact us to create your own limited edition belt.*

NB : Les ceintures que vous allez voir ne sont pas des réalisations, mais des exemples de montages possibles

*The belts shown are illustrations only*

Tsunami Hokusai



Bold and Bright Piet Mondrian

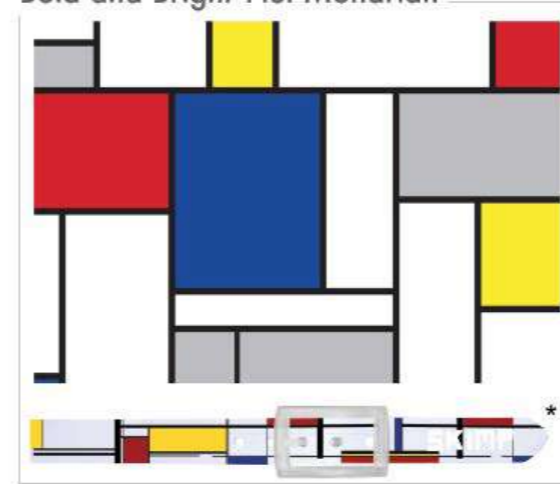

La nuit étoilée Van Gogh



Les femmes d'Alger Picasso



Yellow Red Blue Kandinsky



Motif Memphis

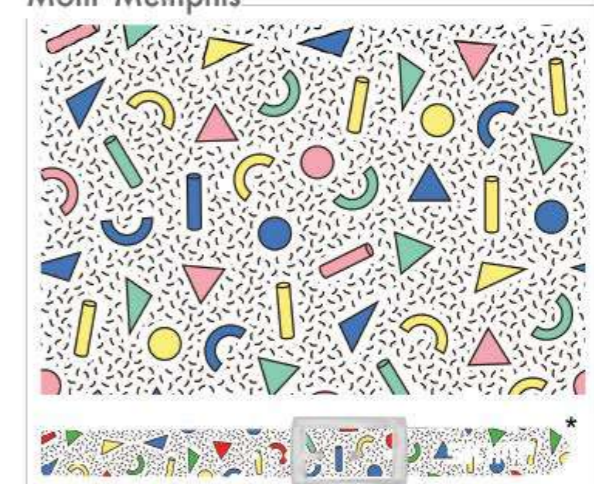

\* Exemples de montage & réalisations / *examples of possible layouts*



# CREEZ UNE CEINTURE A VOS COULEURS

CREATE YOUR BELT

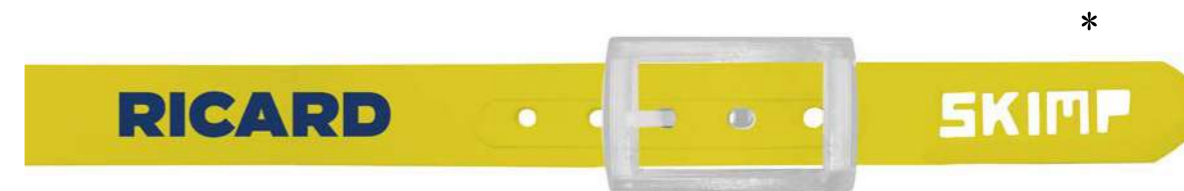

Caractéristiques techniques / *technical characteristics*

Impression sur base ceinture blanche

*Printed on a white belt*

Production par multiple de 60 pièces

*Produced in multiples of 60 pieces*

Délais de production - 15 jours

*Production time - 15 days*

Imprimée en France

*Printed in France*



\* Exemples de montage & réalisations / *examples of possible layouts*



# PACKAGING

Packaging en plexiglass empilable à volonté pour mettre en valeur les produits dans votre boutique. Gagnez de la place et amusez-vous à construire de nouvelles formes avec le « Playful packaging ».

*Packaging in stackable plexiglas boxes to emphasize products in your shop. Enjoy building new display designs with our « Playful packaging ».*



# PLV - POS DISPLAY

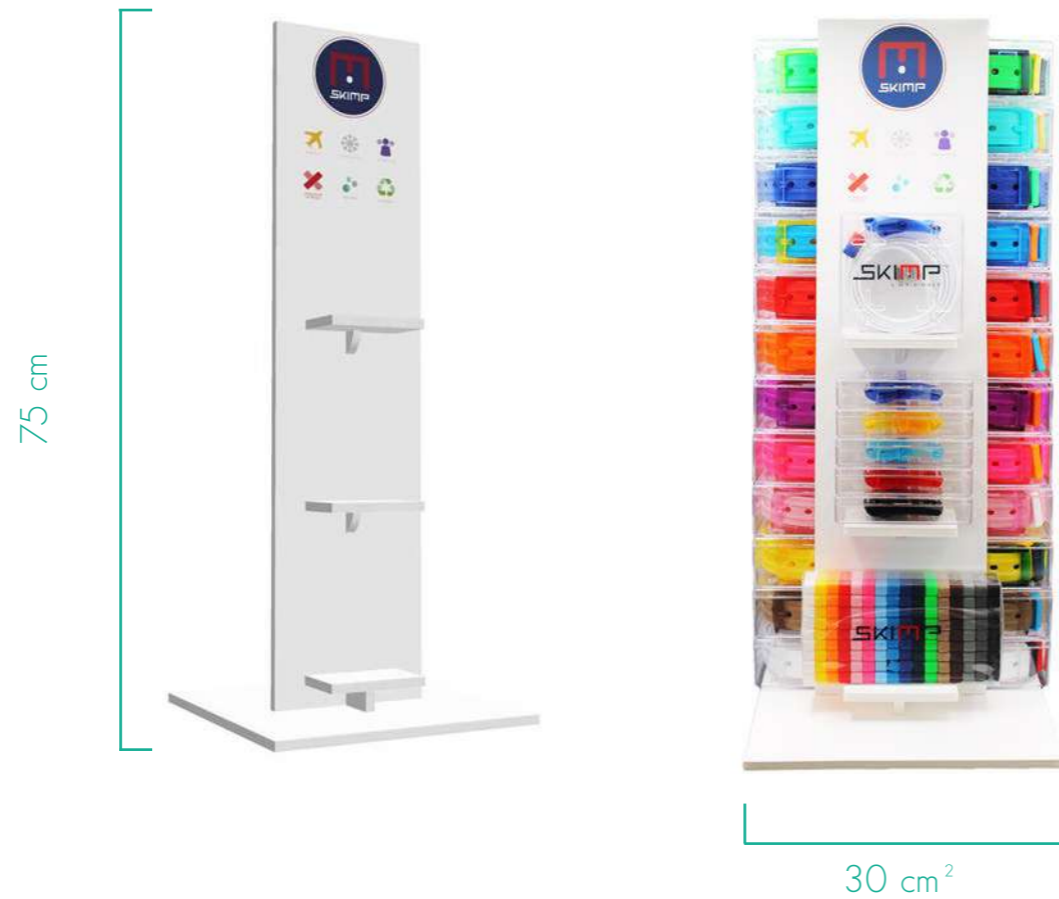

Présentoir ceintures - *Counter belt display*



Totem en carton - *Floor cardboard totem*



# PLV - POS DISPLAY



1 boîte de passants - box of loops  
5 boucles - buckles  
25 ceintures - belts



45 ceintures - belts



27 ceintures - belts

**MERCHANDISING**

Le même présentoir se transforme en 3 versions possibles  
*The counter belt display can be built up in 3 different versions*